



**Ruijie SME RG-EG Series Gateways**

**Hardware Installation and Reference Guide**

## **Copyright Statement**

Ruijie Networks©2020

Ruijie Networks reserves all copyrights of this document. Any reproduction, excerption, backup, modification, transmission, translation or commercial use of this document or any portion of this document, in any form or by any means, without the prior written consent of Ruijie Networks is prohibited.

## **Exemption Statement**

This document is provided "as is". The contents of this document are subject to change without any notice. Please obtain the latest information through the Ruijie Networks website. Ruijie Networks endeavors to ensure content accuracy and will not shoulder any responsibility for losses and damages caused due to content omissions, inaccuracies or errors.



## Preface

Thank you for using our products. This manual will guide you through the installation of the device.

This manual describes the functional and physical features and provides the device installation steps, hardware troubleshooting, module technical specifications, and specifications and usage guidelines for cables and connectors.

## Audience

It is intended for the users who have some experience in installing and maintaining network hardware. At the same time, it is assumed that the users are already familiar with the related terms and concepts.

## Obtaining Technical Assistance

- Ruijie Networks Website: <https://www.ruijienetworks.com/>
- Technical Support Website: <https://ruijienetworks.com/support>
- Case Portal: <http://caseportal.ruijienetworks.com>
- Community: <http://community.ruijienetworks.com>
- Technical Support Email: [service\\_rj@ruijienetworks.com](mailto:service_rj@ruijienetworks.com)
- Skype: [service\\_rj@ruijienetworks.com](https://www.skype.com/people/service_rj@ruijienetworks.com)

## Related Documents

Documents	Description
Configuration Guide	Describes network protocols and related mechanisms that supported by the product, with configuration examples.
Command Reference	Describes the related configuration commands, including command modes, parameter descriptions, usage guides, and related examples.

## Symbol Conventions

---

 Means reader take note. Notes contain helpful suggestions or references.

---

 Means reader be careful. In this situation, you might do something that could result in equipment damage or loss of data.

---

# 1 Product Overview

Featured with global-leading semiconductor technologies and communication control technologies, Ruijie EG series breakout gateway is a data communication product developed by Ruijie Networks with independent intellectual property right. The EG series breakout gateway is designed according to international standards, similar to the mainstream breakout gateway products in the international market. By reading this manual, a network administrator familiar with mainstream breakout gateway configuration commands can use this device without training.

## 1.1 RG-EG105G-P

### Specifications

<b>Model</b>	RG-EG105G-P
<b>Storage</b>	DDR2 SDRAM: 128MB
	ROM: 16MB
<b>Power Module</b>	External 60W power adapter
<b>Interface Standard</b>	Ethernet: 10Base-T/100Base-TX/1000Base-TX
<b>Dimension (without rubber pads) (W x H x D)</b>	206.5 mm x 28 mm x 108.5 mm (8.13 in. x 1.1 in. x 4.27 in.)
<b>Voltage</b>	100V to 240V~, 50/60Hz, 1.5A max.
<b>Power Consumption</b>	Less than 60W (With PoE)
<b>PoE</b>	IEEE 802.3af/at, 54W max. output
<b>Working Temperature</b>	0°C to 40°C (32°F to 104°F)
<b>Working Humidity</b>	10% to 90% RH (non-condensing)

⚠ Please avoid the vibration and collision in the process of moving and usage.

⚠ Products should be transported in original package.

### Appearance

Figure 1-1 Front Panel of RG-EG105G-P

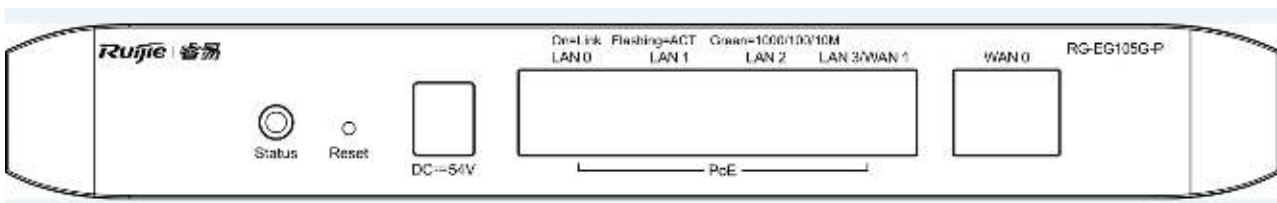

Figure 1-2 Back Panel of RG-EG105G-P



## Interface

Interface	Description
WAN	1 WAN port, used to connect to the DSL/Cable modem for Internet access.
LAN	4 LAN ports, used to connect the computer to the switch or access point (AP). The LAN3 port can be used as a WAN port via the Web configuration.

## LED Indicator

LED Indicator	Description
Status	<p>Blinking green (0.5Hz): PoE is overloaded, or the device is not connected to the Ruijie Cloud.</p> <p>Blinking green (10Hz): restoring the factory default setting, or initializing the system.</p> <p>Solid green: main program initialization is complete, and the device is connected the Ruijie Cloud and working normally.</p>
Link/ACT	<p>Solid green: the port is up.</p> <p>Blinking green: data is being transceived on the port.</p>

## Button

Button	Description
Reset	<p>Press reset button until the status LED blinks green at 10Hz to restore the device to the factory default setting.</p> <p>The default management IP address is <a href="http://192.168.110.1">http://192.168.110.1</a>.</p>

## 1.2 RG-EG105G

### Specifications

<b>Model</b>	RG-EG105G
<b>Storage</b>	DDR2 SDRAM: 128MB
	ROM: 16MB
<b>Power Module</b>	External 12W power adapter
<b>Interface Standard</b>	Ethernet: 10Base-T/100Base-TX/1000Base-TX
<b>Dimension (without rubber pads)</b>	206.5 mm x 28 mm x 108.5 mm (8.13 in. x 1.1 in. x 4.27 in.)

<b>(W x H x D)</b>	
<b>Voltage</b>	100V to 240V~, 50/60Hz, 1.5A max.
<b>Power Consumption</b>	Less than 6W
<b>Working Temperature</b>	0°C to 40°C (32°F to 104°F)
<b>Working Humidity</b>	10% to 90% RH (non-condensing)

 Please avoid the vibration and collision in the process of moving and usage.

 Products should be transported in original package.

## Appearance

Figure 1-3 Front Panel of RG-EG105G

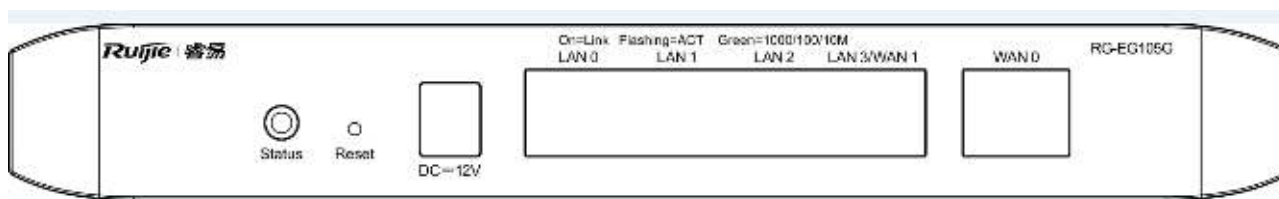

Figure 1-4 Back Panel of RG-EG105G



## Interface

Interface	Description
WAN	1 WAN port, used to connect to the DSL/Cable modem for Internet access.
LAN	4 LAN ports, used to connect the computer to the switch. The LAN3 port can be used as a WAN port via the Web configuration.

## LED Indicator

LED Indicator	Description
Status	<p>Blinking green (0.5Hz): the device is not connected to the Ruijie Cloud.</p> <p>Blinking green (10Hz): restoring the factory default setting, or initializing the system.</p> <p>Solid green: main program initialization is complete, and the device is connected the Ruijie Cloud and working normally.</p>
Link/ACT	<p>Solid green: the port is up.</p> <p>Blinking green: data is being transceived on the port.</p>

## Button

Button	Description
Reset	Press reset button until the status LED blinks green at 10Hz to restore the device to the factory default setting. The default management IP address is <a href="http://192.168.110.1">http://192.168.110.1</a> .

## 1.3 RG-EG205G

### Specifications

Model	RG-EG205G
Storage	DDR3 SDRAM: 256MB
	ROM: 16MB
Power Module	Built-in power module
Interface Standard	Ethernet: 10Base-T/100Base-TX/1000Base-TX
Dimension (without rubber pads) (W x H x D)	440 mm x 43.6 mm x 200 mm (17.32 in. x 1.72 in. x 7.87 in.)
Voltage	100V to 240V~, 50/60Hz, 0.6A max.
Power Consumption	Less than 20W
Working Temperature	0°C to 40°C (32°F to 104°F)
Working Humidity	10% to 90% RH (non-condensing)

 Please avoid the vibration and collision in the process of moving and usage.

 Products should be transported in original package.

### Appearance

Figure 1-5 Front Panel of RG-EG205G

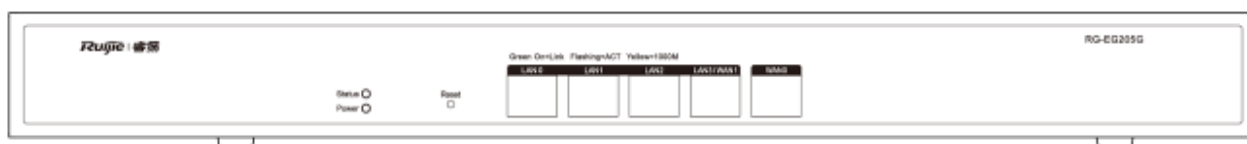
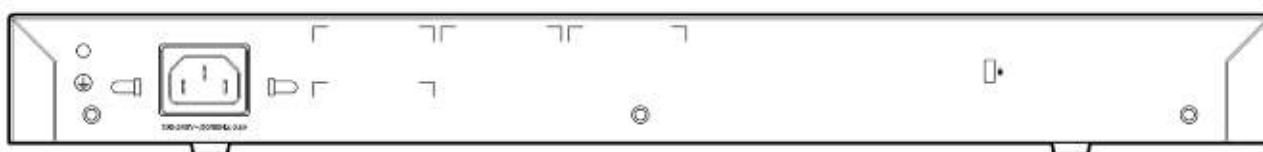

Figure 1-6 Back Panel of RG-EG205G



### Interface

Interface	Description
WAN	1 WAN port, used to connect to the DSL/Cable modem for Internet access.
LAN	4 LAN ports, used to connect the computer to the switch. The LAN3 port can be used as a WAN port via the Web configuration.

## LED Indicator

LED Indicator	Description
Status	Blinking green (0.5Hz): the device is not connected to the Ruijie Cloud. Blinking green (10Hz): restoring the factory default setting, or initializing the system. Solid green: main program initialization is complete, and the device is connected the Ruijie Cloud and working normally.
Power	Solid green: the power module is operational. Off: the power module is off or faulty.
Link/ACT	Solid green: the port is up. Blinking green: data is being transceived on the port.
Speed	Solid yellow: the port is connected at 1000 Mbps. Off: the port is not connected at 1000 Mbps.

## Button

Button	Description
Reset	Press reset button until the status LED blinks green at 10Hz to restore the device to the factory default setting. The default management IP address is <a href="http://192.168.110.1">http://192.168.110.1</a> .



## 1.4 RG-EG105GW

### Specifications

<b>Model</b>	RG-EG105GW
<b>Storage</b>	DDR3 SDRAM: 128MB
	ROM: 16MB
<b>Power Module</b>	Built-in power module
<b>Interface Standard</b>	Ethernet: 5 x 10Base-T/100Base-TX/1000Base-TX ports (4 LAN ports and 1 WAN port by default) 1 USB2.0 port
<b>Transmission Protocol</b>	Concurrent 802.11b/g/n and 802.11a/n/ac.



<b>Operating Bands</b>	802.11b/g/n: 2.4GHz to 2.483GHz 802.11a/n/ac: 5.15GHz to 5.35GHz, 5.47GHz to 5.725GHz, 5.725GHz to 5.85GHz (Country-Specific)
<b>Max Throughput</b>	2.4G: up to 450Mbps 5G: up to 867Mbps Up to 1.317Gbps per device
<b>Transmit Power</b>	27dBm (2.4G) + 25dBm (5G) (Country-Specific)
<b>Dimension (without rubber pads) (W x H x D)</b>	250 mm x 42 mm x 174 mm (9.84 in. x 1.65 in. x 6.85 in.)
<b>Voltage</b>	100V to 240V~, 50/60Hz, 0.6A max.
<b>Power Consumption</b>	Less than 21W
<b>Working Temperature</b>	0°C to 40°C (32°F to 104°F)
<b>Working Humidity</b>	10% to 90% RH (non-condensing)

-  Please avoid the vibration and collision in the process of moving and usage.
-  Products should be transported in original package.
-  Since there are numerous types of U-disk, we cannot ensure that the system supports all of them. The Kingston and SanDisk U-disk with FAT 32 are recommended to be used.

## Appearance

Figure 1-7 Front Panel of RG-EG105GW

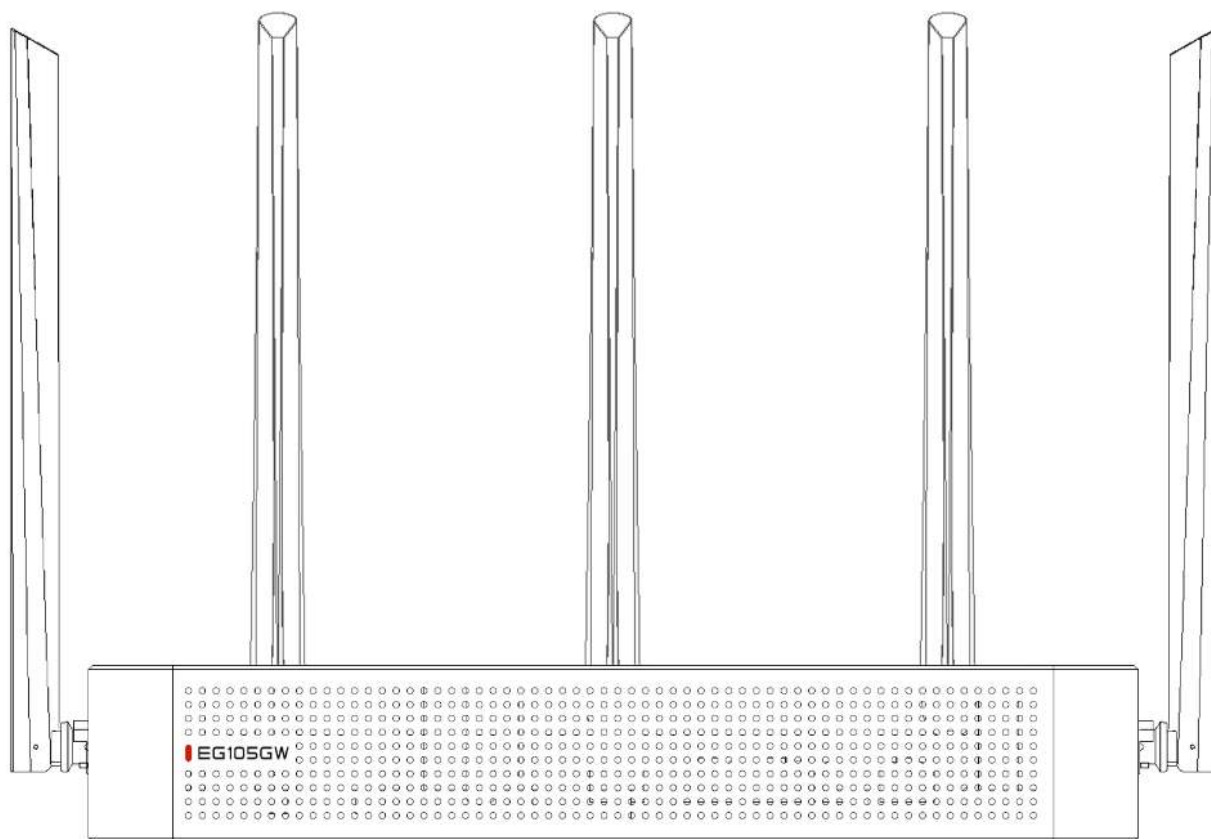
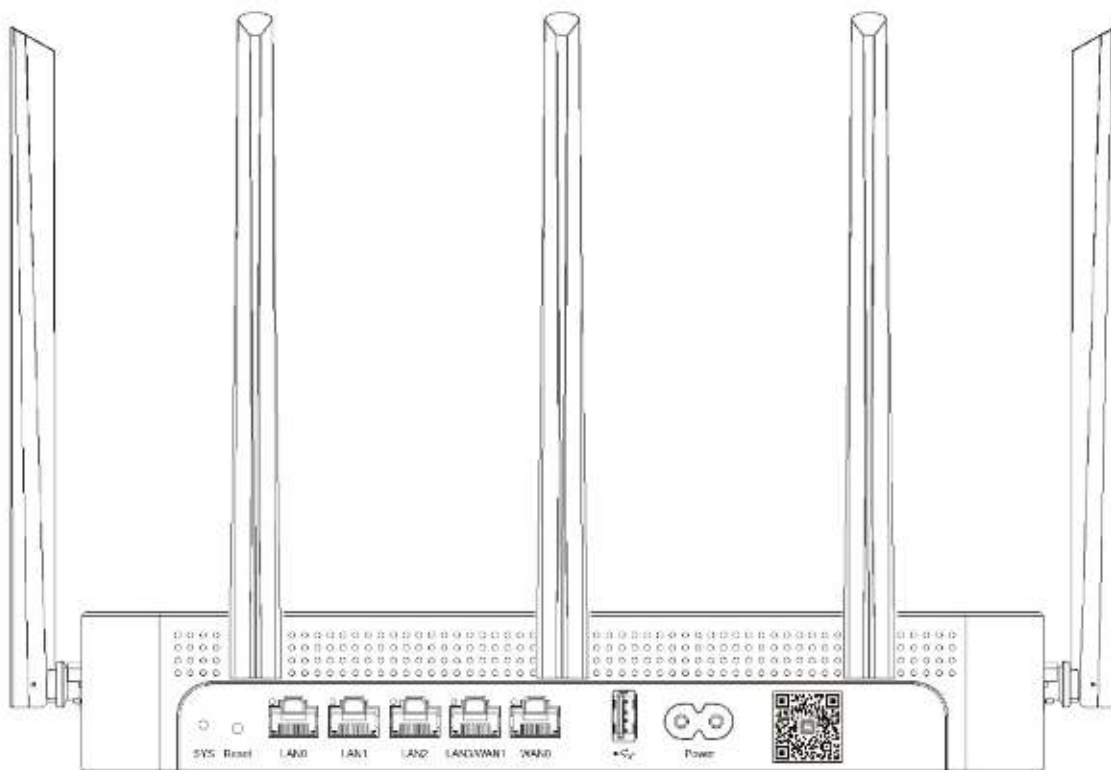

Figure 1-8 Back Panel of RG-EG105GW



## Interface

Interface	Description
WAN	1 WAN port, used to connect to the DSL/Cable modem for Internet access.
LAN	4 LAN ports, used to connect the computer to the switch. The LAN3 port can be used as a WAN port via the Web configuration.

## LED Indicator

LED Indicator	Description
SYS	Blinking green (0.5Hz): the device is not connected to the Ruijie Cloud. Blinking green (10Hz): restoring the factory default setting, or initializing the system. Solid green: main program initialization is complete, and the device is connected the Ruijie Cloud and working normally.
Speed	Solid green: the port is connected at 10/100/1000 Mbps. Off: the port is not connected at 10/100/1000 Mbps.

## Button



Button	Description
Reset	Press reset button until the status LED blinks green at 10Hz to restore the device to the factory default setting. The default management IP address is <a href="http://192.168.110.1">http://192.168.110.1</a> .

## 1.5 RG-EG210G-P

### Specifications

<b>Model</b>	RG-EG210G-P
<b>Storage</b>	DDR3 SDRAM: 256MB
	ROM: 16MB
<b>Power Module</b>	External 80W power adapter
<b>Interface Standard</b>	Ethernet: 10Base-T/100Base-TX/1000Base-TX
<b>Dimension (without rubber pads) (W x H x D)</b>	202 mm x 28 mm x 108 mm (7.95 in. x 1.1 in. x 4.25 in.)
<b>Voltage</b>	100V to 240V~, 50/60Hz, 1.5A max.
<b>Power Consumption</b>	Less than 80W (With PoE)
<b>PoE</b>	IEEE 802.3af/at, 70W max. output

<b>Working Temperature</b>	0°C to 40°C (32°F to 104°F)
<b>Working Humidity</b>	10% to 90% RH (non-condensing)

-  Please avoid the vibration and collision in the process of moving and usage.
-  Products should be transported in original package.

### Appearance

Figure 1-9 Front Panel of RG-EG210G-P

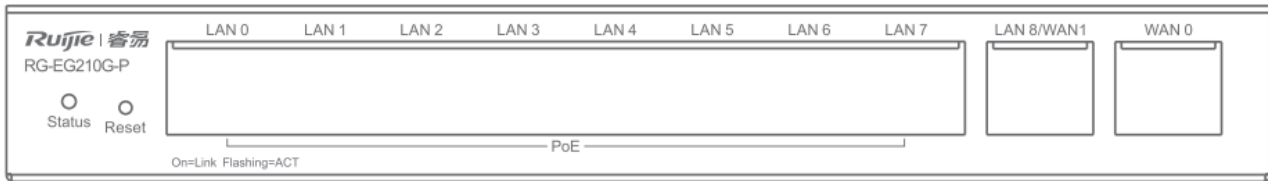
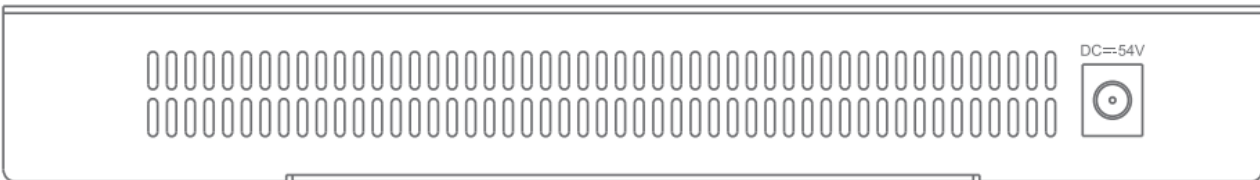

Figure 1-10 Back Panel of RG-EG210G-P



### Interface

Interface	Description
WAN	1 WAN port, used to connect to the DSL/Cable modem for Internet access.
LAN	9 LAN ports, used to connect the computer to the switch or access point (AP). The LAN8 port can be used as a WAN port via the Web configuration.

### LED Indicator

LED Indicator	Description
Status	<p>Blinking green (0.5Hz): PoE is overloaded, or the device is not connected to the Ruijie Cloud.</p> <p>Blinking green (10Hz): restoring the factory default setting, or initializing the system.</p> <p>Solid green: main program initialization is complete, and the device is connected the Ruijie Cloud and working normally.</p>
Link/ACT	<p>Solid green: the port is up.</p> <p>Blinking green: data is being transceived on the port.</p>

### Button

Button	Description
Reset	Press reset button until the status LED blinks green at 10Hz to restore the device to the factory default setting. The default management IP address is <a href="http://192.168.110.1">http://192.168.110.1</a> .

## 1.6 APs Supporting EG105G-P and EG210G-P

Model	Max Consumption	Hardware Version
EAP101	12.95W	V2.00, V3.00
EAP102	12.95W	V2.00
EAP201	12.95W	V2.00
EAP202	12.95W	V2.00

---





 Please do not use APs not included in the list.

---

## 2 Preparation

### 2.1 Safety Precaution

The breakout gateway acts as the critical transfer station of network connections, and its normal service is crucial to the normal operation of the entire network.

- Do not place the device in a watery place and prevent any liquid from entering into it.
  - Keep the device away from heat sources.
  - Ensure the normal grounding of device.
  - Wear an anti-static wrist strap to install and maintain the device.
  - Do not wear loose clothes to avoid hooking any parts. Before operation, tighten your band, shawl and sleeves.
  - Keep tools and parts away from the walkway to avoid damage.
  - Use the uninterruptible power supply (UPS) to avoid power failure and other interferences.
  - If the system time is incorrect, check whether you have set the clock. If the clock is not set, the time may not be correct; if the clock has been set precisely and the time is still incorrect, the built-in button cell of device may have ran out, which is typically happened after 10-year service.
  - Install and use the device in restricted access locations.
- 
-  Use of wrong battery may cause damage to the device. Do not replace the battery by yourself. Please contact the technical support for help.
-  This is a Class-A product which may cause radio interference in the living environment. In such a case, the user may need to take feasible measures against such interference.
-  Install and use the device in restricted access locations.
-  Invite professionals and related technicians to install this type of device.
- 

### 2.2 Installation Environment

Ruijie EG series breakout gateway products are for indoor use only. To ensure normal operation and prolong their service life, the installation site must meet the following requirements:

#### 2.2.1 Temperature/humidity requirements

To ensure normal operation and prolong the service life of the device, the equipment room must maintain constant temperature and humidity. If the equipment room is overheated for a long time, the insulation materials may result in defective insulation and even electric leakage. If the relative humidity is low, the insulation spacer may result in dry shrinkage, which will make screws looser and easily generate static electricity in the dry environment, thus damaging the interior circuits on the device. Excessively high temperature will accelerate the aging of insulation materials and compromise the reliability and even service life of the device. The temperature/humidity requirements are shown below (detailed difference between products is described in *Product Overview*):

---

Temperature		Relative Humidity	
Long-term	Short-term	Long-term	Short-term
15°C to 30°C/ 59°F to 86°F	0°C to 45°C/ 32°F to 113°F	40% to 65%	10% to 90%

- i** The temperature/humidity of working environment indicates the value measured at 1.5 m above the floor and 0.4 m ahead of the equipment frame when there is no protection plate on the front and rear side of the equipment frame.
- i** Short-term working condition refers to the continuous operation no exceeding 48 hours or accumulative operations no exceeding 15 days in a year.
- i** Extremely harsh working environment generally refers to the ambient temperature and humidity which may be encountered when the equipment room air-conditioning system fails but will recover in less than 5 hours every time.

## 2.2.2 Cleanliness

The dust is also a major threat to the safe operation of device. The dust accumulated on the device may cause electrostatic adsorption and result in poor contact. It will not only compromise the service life of device but also cause communication failure. When the indoor relative humidity is low, such electrostatic adsorption will occur more easily.

Maximum Diameter ( $\mu\text{m}$ )	0.5	1	3	5
Maximum Density (Particles/ $\text{m}^3$ )	$1.4 \times 10^7$	$7 \times 10^5$	$2.4 \times 10^5$	$1.3 \times 10^5$

Apart from the dust, the device is also sensitive to the hydrochloric acid sulfide contained in the air. These noxious gases will accelerate metal wastage and the aging of certain parts. The upper limits of noxious gases (Sulfur dioxide, Sulfured hydrogen, Nitrogen dioxide, Ammonia and Chlorine) in the following table:

Gas	Average ( $\text{mg}/\text{m}^3$ )	Maximum ( $\text{mg}/\text{m}^3$ )
SO <sub>2</sub>	0.2	1.5
HS	0	0.03
NO <sub>2</sub>	0.04	0.15
N <sub>2</sub>	0.05	0.15
Cl <sub>2</sub>	0.01	0.3

## 2.2.3 ESD

The breakout gateway has already given consideration to electrostatic prevention during circuit design, but excessively strong static electricity will still damage the circuit board. The static electricity in the communication network connected with the device is mainly from:

- Outdoor high-voltage transmission line, lightning and other exterior electric fields.
- Indoor environment, flooring material, complete appliance structure and other in-house systems.

To avoid the damage caused by static electricity, we shall:

- Properly ground the device and floor.
- Apply indoor dust control.
- Maintain proper temperature and humidity.
- Before touching the circuit board, wear an anti-static wrist strap and an anti-static uniform.
- Place the circuit board disassembled face up on the antistatic workbench or in the electromagnetic shielded bag.

- When observing or transferring the circuit board of breakout gateway, touch the outer edge of circuit board and avoid direct contact with the components on the circuit board.

## 2.2.4 Anti-Interference

The interference as mentioned herein refers to electromagnetic or electrical interference, and the anti-interference requirements are described below:

- Effective power grid interference control measures shall be taken against the power supply system.
- The working ground of the breakout gateway shall be kept far away from the grounding device or lightning grounding device of power equipment instead of sharing.
- The gateway shall be kept far away from high-power radio-transmitting station, radar-transmitting station and other high-frequency & heavy-current devices.
- Electromagnetic shielding measures shall be taken whenever necessary.

## 2.2.5 Installation Site

No matter the breakout gateway is installed in the cabinet or on the workbench, the following requirements shall be met:

- Make sure sufficient room has been reserved for the air intake and air vent of breakout gateway to facilitate the heat elimination of the gateway chassis. It is recommended to install the breakout gateway in the 19-inch standard cabinet. Otherwise, install it on a clean and flat surface. In heated areas, the air conditioning system shall be equipped.
- Make sure the cabinet and workbench is equipped with a good ventilation and cooling system.
- Make sure the cabinet and workbench is steady enough and capable of withstanding the weight of the breakout gateway and its accessories.
- Make sure the cabinet and workbench is properly grounded.

## 2.3 Installation Tools and Devices

Please prepare the following tools and devices:

<b>Installation Tools</b>	Phillips screwdriver, ESD wrist strap
<b>Cables</b>	Power cables, configuration cables, Ethernet cables, grounding wires
<b>Devices</b>	HUB or switch, configuration terminal (PC with hyper-terminal), power socket



## 3 Installing Breakout Gateway

### 3.1 Installation Flowchart

Please take the following steps:

Figure 3-1 Installation Flowchart

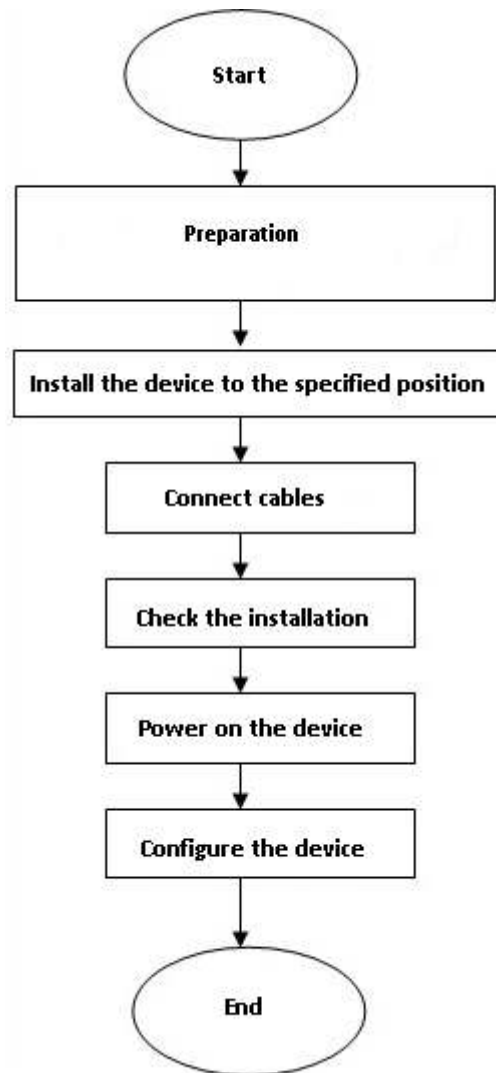

### 3.2 Mounting the Breakout Gateway

Mounting the breakout gateway refers to installing the device to the specified position. Upon completion of installation preparation, fix the breakout gateway to the specified position. The installation position of breakout gateway is generally a cabinet or a workbench.

#### Mounting on a Workbench

In most cases, the user does not have a standard cabinet. Instead, the user can place the device on a clean workbench. Although it is easy and simple, you shall pay attention to the following:

- Guarantee the steadiness and good grounding of the workbench.
- Attach the rubber pads onto the small holes at the bottom of the breakout gateway, and maintain a minimum of 10 cm around the device.
- Do not place heavy things on the device.

### 3.3 Installing Power Cables

The requirements of Ruijie EG series breakout gateway products on AC power supply are described below (refer to *Product Overview* for detailed parameters):

100–240 V / 50/60 Hz.

Breakout gateway uses 3-conductor power cables. You are suggested to use a single-phase 3-conductor outlet or a multifunction microcomputer outlet with neutral connector. The neutral point of the power supply shall be securely grounded in the building. In most buildings, the neutral point of a power supply has been grounded during the construction. You need to make sure the power supply is properly grounded.

Please take the following steps:

- Plug one end of the power cable into the power socket on the backpanel of a breakout gateway, and plug the other end into the AC power supply outlet.
- Check whether the power LED on the front panel of the breakout gateway lights up or not. The LED indicator will light up if the power supply is properly connected.

### 3.4 Checking after the Installation

After completing the mechanical installation of breakout gateway, perform the following checks before powering on the device:

- If the device is installed in a cabinet, check whether the angle bar for device installation is steady. If the device is installed on the workbench, check whether sufficient room is reserved around the device to ensure heat elimination and whether the workbench is steady.
  - Check whether the power supply meets the requirements.
  - Check whether the earth wire of device is properly connected.
  - Check whether the device is connected correctly to the configuration terminal.
-

## 4 Quick Configuration

### 4.1 Connecting Devices

#### Connecting to AP

1. Connect the AP device to the EG gateway via network cable.
2. Power on the devices.
3. The AP device broadcasts an SSID with a prefix starting with @Ruijie-m.

#### Connecting to PC

1. Connect the PC to the EG gateway via network cable.
2. Enable the PC to automatically obtain the IP address.

### 4.2 Power-on Startup

#### Checks before Power-on

Before power-on, perform the following checks on the breakout gateway:

- Whether the power cable and the ground wire are properly connected.
- Whether the power voltage is consistent with the requirement of the breakout gateway.
- Whether the configuration cable is properly connected, and whether the microcomputer or terminal for gateway configuration is started or configured.

---

 Before powering on the breakout gateway, be aware of the location of the power switch of the breakout gateway to timely cut off power supply in case of any accident.

---

#### Powering on the Breakout Gateway

- Turn on the power supply switch of the breakout gateway.

#### Checks after Power-on

After the breakout gateway is powered on, check the following items:

- Whether the LED indicators on the front panel of the breakout gateway works normally.

Refer to the indicators in *Product Overview*.

- Whether the Web-based system is available.

The default management IP address is `http://192.168.110.1`.

---

## 4.3 Configuring Breakout Gateway

To use the breakout gateway, you need to properly configure the breakout gateway as required. Refer to the relevant Web-based configuration guide for details about breakout gateway configuration.

---

## 5 Troubleshooting

### 5.1 Power Supply

Refer to *Product Overview* for the normal state descriptions of LED indicators. If abnormality occurs, perform the following checks:

- Whether the power switch is turned on.
- Whether the power supply of the breakout gateway is turned on.
- Whether the power cable is properly connected.
- Whether the power supply to the breakout gateway meets relevant requirements.

---

 Do not plug or pull the power cable when the device is powered on. If everything is ok but the Status LED still does not light up, contact with a local distributor or technical support personnel.

---

### 5.2 Configuration System

After the breakout gateway is powered on, the Web-based configuration system is available if the device works normally. If not, please check:

- Whether the power system works normally.
  - Whether the network cable is properly connected.
  - Whether the network card of the computer is using DHCP to obtain the IP address.
-